



:  
RH 1500-32





:

1.	3
2.	3
3.	4
4.	5
5.	8
6.	8
	9

1.

1.1

•

•

•

•

•

•

•

•

•

1.2

•

•

•

•

•

•

•

•

1.3



2.

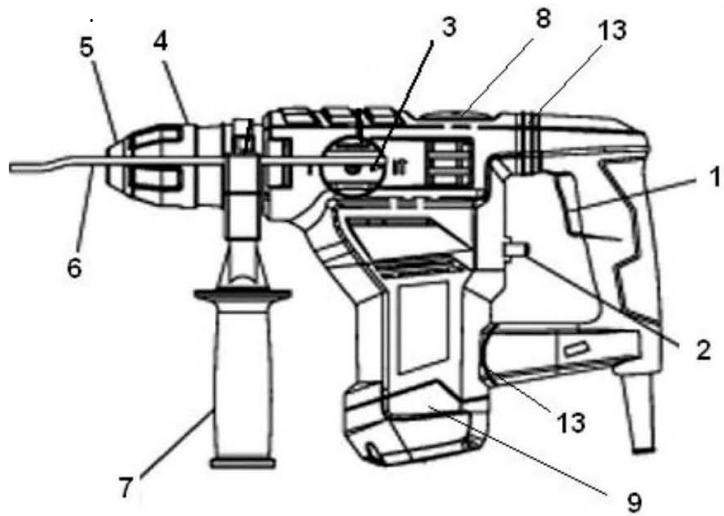

- 1.
- 2.
- 3.
- 4.
- 5.
- 6.



- 7.
- 8.
- 9.

3.

		RH 1500-32
		220/50
		1500
		0-800
		0-3900
		5
		SDS plus
		32
		13
		40
		II
		5,4

4.

- 
- 
- 
- ( )
- ( )

4.1

-

•

« ./ .»

« .».

« .»,

•

•

2

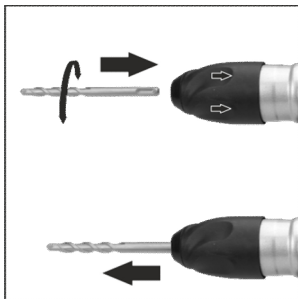

2

•

0,8





!

4.2

( 3).

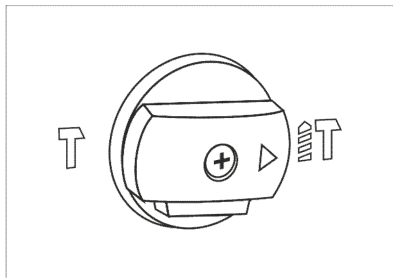

3.

( 4)

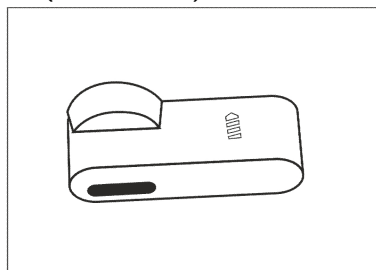
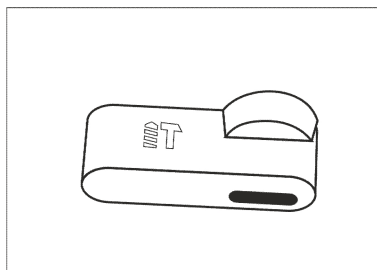

4.

5.

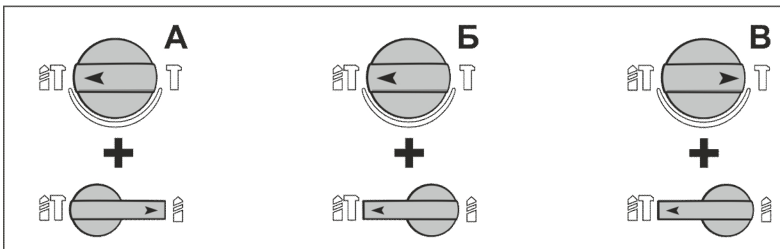

5.



•



•

•

•

•

•

5.



• !

• -

• , -

• -

• (

• )

50

• :

• ( ) 6.

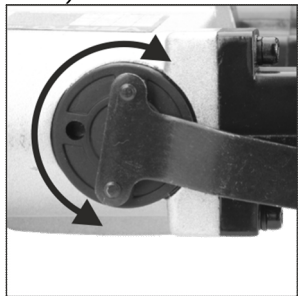

6.

• ( )



- 5 ),

- 

- 

6.

5.1

12

5.2

5.3

5.4





8 (7172) 55-44-40 , 8/1

8 (727) 311-77-00 , 157

8 (7252) 99-77-11 , 49 ( " ")

8 (7122) 55 66 00 , 45

**КОНТАКТ ЦЕНТРЫ**

АСТАНА	8 (7172) 55 44 40
АЛМАТЫ	8 (727) 331 77 00
ШЫМКЕНТ	8 (7252) 99 77 11
АТЫРАУ	8 (7122) 55 66 00

[www.tssp.kz](http://www.tssp.kz)

**TSSP**

ПРЕВЫШАЯ СТАНДАРТЫ

